

Proton Launch System Mission Planner's Guide

APPENDIX F

Proton Launch System Options and Enhancements

F. PROTON LAUNCH SYSTEM OPTIONS AND ENHANCEMENTS

The missions presented in the previous sections represent standard Geosynchronous Transfer Orbit (GTO)/ Geostationary Orbit (GSO) missions for the Proton M Launch Vehicle (LV) with the Breeze M Upper Stage. ILS can take advantage of the unique capabilities of the Proton launch system to design non-standard mission profiles to meet unique mission and payload requirements.

The long coast life and multiple restart capabilities of the Breeze M can also assist in constellation phasing, thereby reducing SC propellant usage.

ILS/KhSC also has the resources available to develop special hardware items, such as dispensers for multiple SC, to meet unique mission requirements.

F.1 LEO MISSIONS

Please contact ILS for specific Low Earth Orbit (LEO) mission performance.

F.2 MEO MISSIONS (INTERMEDIATE CIRCULAR ORBITS)

The Proton launch system performance and Breeze M restart capability allow Proton great flexibility in delivering payloads to circular Medium Earth Orbits (MEO). Table F.2-1 shows Proton M Breeze M Payload Systems Mass (PSM) performance and mission duration for injection into representative MEO target orbits.

Table F.2-1: Proton M Breeze M Performance to Intermediate Circular Orbits

Circular Orbit Altitude (km)	Proton M Breeze M PSM to Each Orbital Inclination (kg)					Mission Duration (hrs)
	15 deg	28.6 deg	45 deg	51.5 deg	63.4 deg	
10000	4115	5634	7650	7650	7272	5.3
15000	4049	5142	6491	6580	6225	6.1
20000	3852	4908	5756	5843	5575	6.9
Performances have been calculated for the standard Payload Fairing (PLF) (15,255 mm long). Free Molecular Heat Flux (FMHF) at the PLF jettison does not exceed 1135 W/m ² . PSM includes LV AS mass. PSM has been defined for the Breeze M 2.33σ propellant margin.						

Note: Maximum PSM is 7650 kg based on structural capability of Breeze M.

F.3 HIGHLY ELLIPTICAL ORBITS

Proton M Breeze M has high performance to highly inclined, highly elliptical orbits of the Tundra (24-hour) class, since little orbital plane change is required to reach these orbits from the Baikonur Cosmodrome. Table F.3-1 provides Proton M Breeze M performance to representative orbits.

Many other elliptical orbits can be attained by the Breeze M. The Breeze M multiple restart capability can also be used to provide orbit phasing of multiple payloads in the same orbit. Customers are encouraged to contact ILS to discuss specific mission designs that take full advantage of the Breeze M's flexibility.

Table F.3-1: Proton M Breeze M Performance to 24-Hour Orbits

Orbit Parameters				PSM (kg)	Mission Duration (hrs)	Mission Profile
Inclination (deg)	Perigee (km)	Apogee (km)	Argument of Perigee (deg)			
45	27000	44572	270	5055	9.6	Express using an intermediate orbit (5 Breeze M burns)
55	27000	44572	270	5150	9.3	Express using an intermediate orbit (5 Breeze M burns)
63.4	27000	44572	270	4840	9.0	Express using an intermediate orbit (5 Breeze M burns)
Performances have been calculated for the standard PLF (15,255 mm long). FMHF at the PLF jettison does not exceed 1135 W/m ² . PSM includes LV AS mass. PSM has been defined for Breeze M 2.33σ propellant margin.						

Note: Argument of perigee of 270 degrees has the longest coverage from ground stations.

F.4 SUPERSYNCHRONOUS TRANSFER

Use of a Supersynchronous Transfer Orbit (SSTO) can increase performance into GSO. A SSTO takes advantage of the increased efficiency with which the inclination can be changed at the SSTO apogee, the altitude of which is much greater than that of GSO.

Depending on the region in which a SSTO is initiated, the transfer scheme may be of two types:

- 1) A perigee injection supersynchronous transfer orbit, where the SSTO is initiated at perigee.
- 2) An apogee injection supersynchronous transfer orbit, where the SSTO is initiated at apogee.

LV performance and a description for each type of SSTO is discussed below.

ILS is able to assess supersynchronous missions by specific request and with detailed SC configuration data.

It is the responsibility of the Customer or SC manufacturer to account for trajectory perturbations resulting from solar and lunar gravitational effects.

F.4.1 PERIGEE INJECTION SUPERSYNCHRONOUS TRANSFER

Figure F.4.1-1 shows typical Breeze M transfer orbit characteristics for SC injection into SSTO perigee using a 4-hour timeline from the first descending node of the parking orbit. SC injection occurs using a transfer scheme with four Breeze M burns, the successive completion of which places the SC in a parking orbit (after the first burn), an intermediate orbit (after the second burn), and the target orbit (after the third and fourth burns). Transfer of the Orbital Unit (OU) from the parking orbit to the intermediate orbit occurs at the first ascending node. The Auxiliary Propellant Tank (APT) is jettisoned in the interval between the third and fourth burns. The target orbit is initiated at the perigee of the intermediate orbit. To assure SC separation within coverage of Russian ground measurement stations, an argument of perigee of 0° is selected for this SSTO.

The current Breeze M configuration supports SC perigee injection into a SSTO over a 4.25-hour period, regardless of the SSTO apogee.

Figure F.4.1-2 shows a typical Proton M/Breeze M ground track for SC perigee injection into SSTO using a 4-hour timeline from the first ascending node of a parking orbit inclined at 51.5° .

Table F.4.1-1 shows Proton M/Breeze M performance during SC perigee injection into SSTO from the first ascending node of a parking orbit inclined at 51.5° . The SSTO apogee lies in the range between 48,400 km and 100,000 km. Figure F.4.1-3 provides optimum Proton M Breeze M SSTO SC injection performance capability from the first ascending node of the parking orbit (inclination of 51.5°) to various apogees.

Figure F.4.1-1: Typical 4-hour Breeze M Flight for SC Perigee Injection into SSTO from the First Ascending Node of a Parking Orbit Inclined at 51.5°

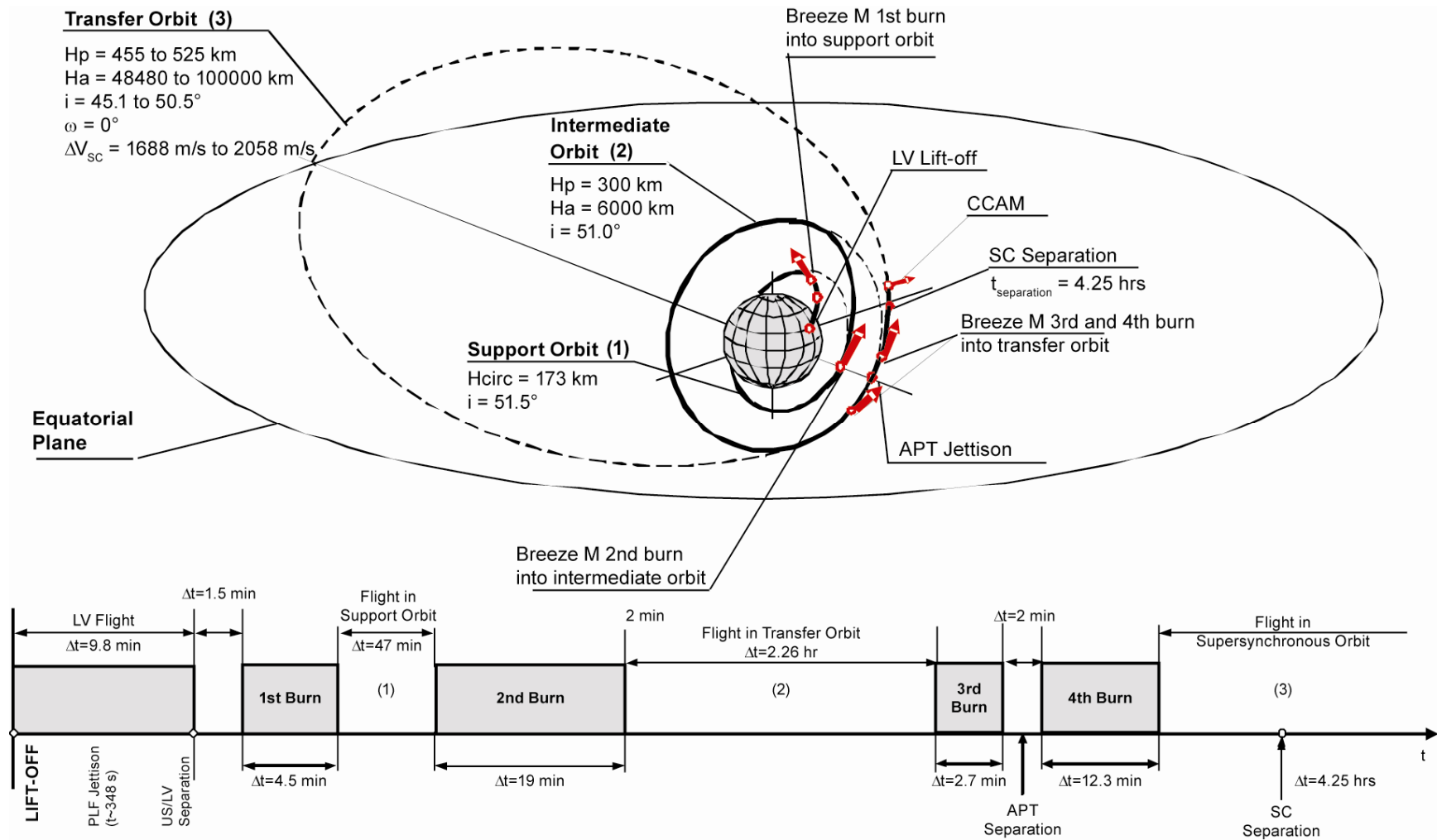
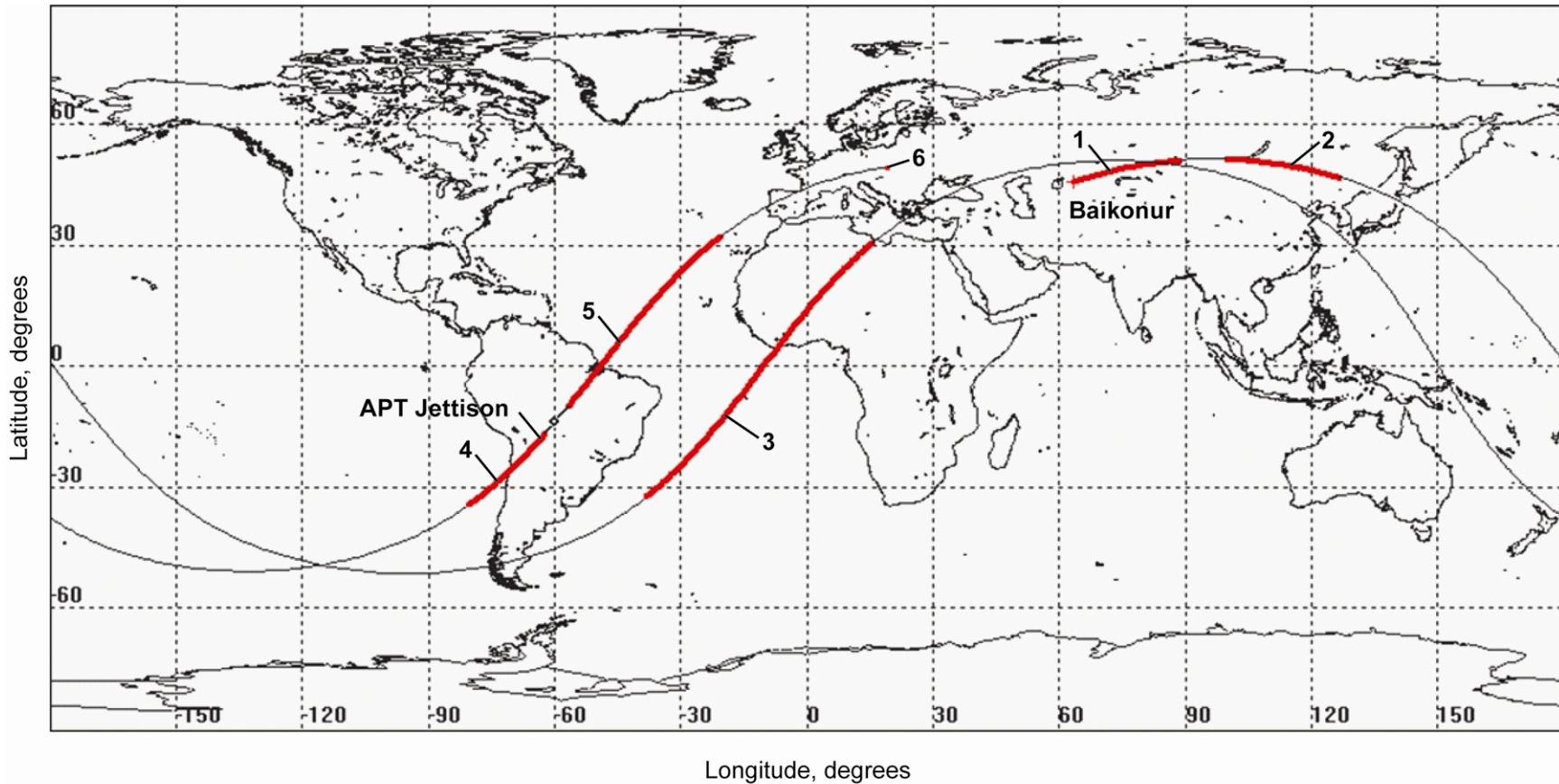

Figure F.4.1-2: Typical Proton M/Breeze M Ground Track for SC Perigee Injection into SSTO ($H_a = 100,000$ km) Using a 4-hour Timeline from the First Ascending Node of a Parking Orbit Inclined at 51.5°



- 1 - LV Insertion Phase
- 2 - Breeze M main engine first burn and flight to support orbit
- 3 - Breeze M main engine second burn and flight to intermediate orbit
- 4, 5 - Breeze M main engine third and fourth burn and flight to supersynchronous transfer orbit
- 6 - SC Separation

Table F.4.1-1: Proton M/Breeze M Performance for SC Perigee Injection into SSTO from the First Ascending Node of a Parking Orbit Inclined at 51.5° (Mission with Four Breeze M Burns)

PSM (kg)	SSTO Parameters				Minimum SC Velocity for Transfer to GSO, ΔV_{sc} (m/s)
	Inclination (deg)	Perigee Altitude (km)	Apogee Altitude (km)	Argument of Perigee (deg)	
6650	45.3	525	100000	0	1688.5
	45.1	520	96780	0	1698.0
6750	46.0	520	100000	0	1696.3
	45.2	510	87820	0	1736.0
6850	46.7	515	100000	0	1704.1
	45.3	500	80470	0	1773.0
6950	47.5	510	100000	0	1713.0
	45.4	492	74160	0	1810.0
7050	48.5	505	100000	0	1724.4
	45.5	485	68710	0	1847.0
7150	50.1	500	100000	0	1742.4
	45.6	480	64080	0	1883.0
7165	50.5	499	100000	0	1747.0
7250	50.5	493	92000	0	1782.4
	45.7	475	59990	0	1919.0
7350	50.5	487	83500	0	1826.6
	45.83	470	56520	0	1954.0
7450	50.5	480	76340	0	1870.5
	46.0	465	53490	0	1989.0
7550	50.5	473	70260	0	1913.9
	46.2	460	50820	0	2024.0
7650	50.5	467	64980	0	1957.4
	46.4	455	48480	0	2058.0

Injection time is 4.25 hours.
 Performances have been calculated for the standard PLF (15,255 mm long).
 FMHF at the PLF jettison does not exceed 1135 W/m².
 PSM includes LV AS mass.
 PSM has been defined for the Breeze M 2.33 σ propellant margin.
 During the transfer to GSO (GSO $i = 0^\circ$, $H_{cir} = 35,786$ km), the SC decreases inclination at both the apogee and perigee of the SSTO.

Note. The table does not consider perturbations resulting from solar and lunar gravitational effects.

Figure 4.1-3: Payload System Mass Injected Into an Optimum SSTO from the First Ascending Node of a Parking Orbit Inclined at 51.5°
(Mission with Four Breeze M Burns)

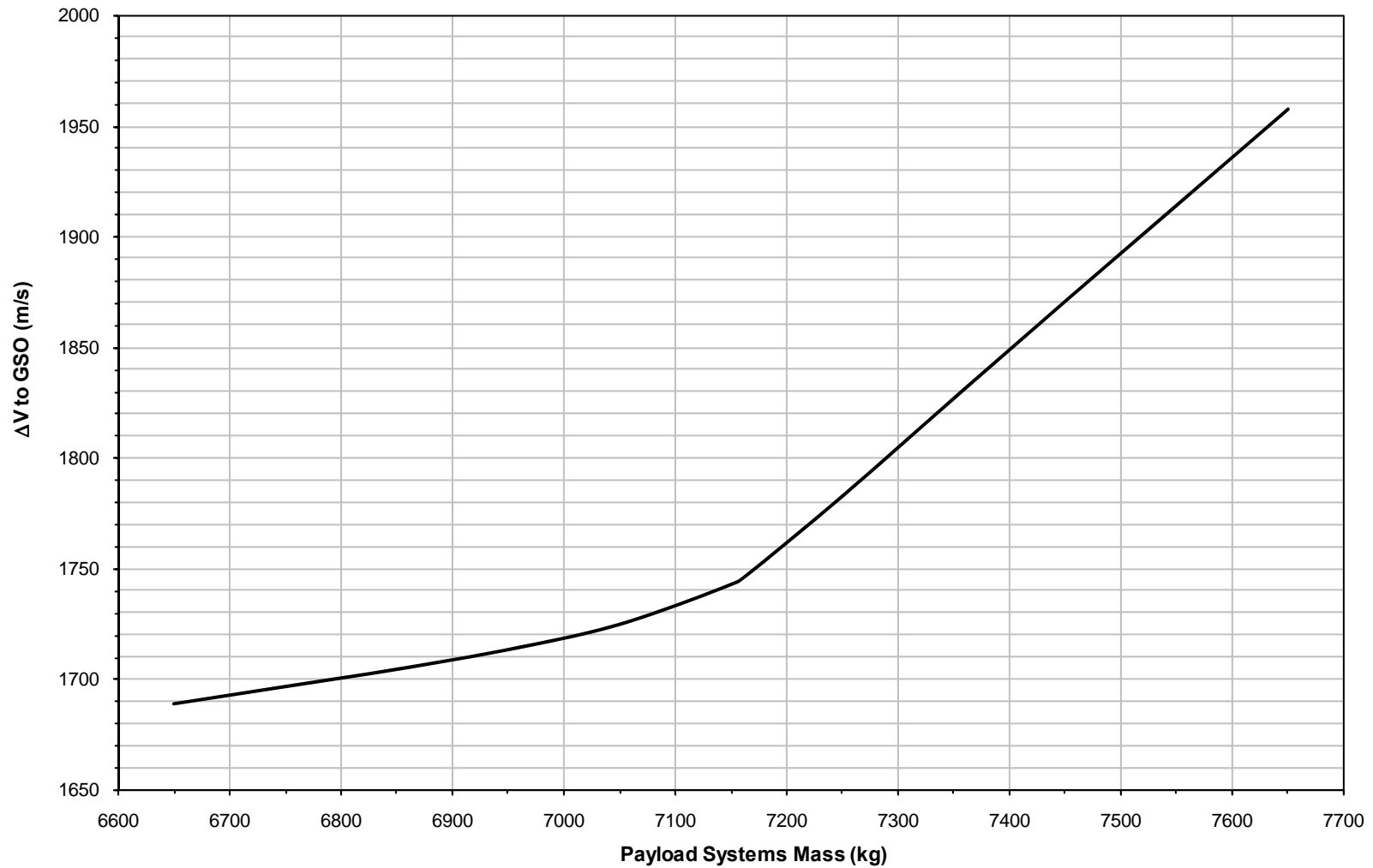

F.4.2 APOGEE INJECTION SUPERSYNCHRONOUS TRANSFER

A number of LV hardware and SC operational constraints may affect the design of missions utilizing apogee injection supersynchronous transfer.

Figure F.4.2-1 shows typical Breeze M transfer orbit characteristics for SC injection into SSTO ($H_a = 65,000$ km) using a 15-hour apogee injection timeline from the second descending node of a parking orbit inclined at 51.5° . SC injection occurs using a transfer scheme with five Breeze M burns, the successive completion of which places the SC in a parking orbit (after the first burn), an intermediate orbit (after the second burn), a transfer orbit (after the third and fourth burns), and the target orbit (after the fifth burn). Transfer of the OU from the parking orbit to the intermediate orbit occurs at the second descending node of the parking orbit. The APT is jettisoned in the interval between the third and fourth burns. SSTO is initiated at the transfer orbit apogee.

An argument of perigee of 180° is selected to assure SC separation within coverage of Russian ground measurement stations.

Figure F.4.2-2 shows a typical Proton M/Breeze M ground track for SC apogee injection into SSTO ($H_a = 65,000$ km) using a 15-hour timeline from the second descending node of the parking orbit.

Table F.4.2-1 shows SC injection times and SC separation longitudes as a function of SSTO apogee.

Table F.4.2-2 provides SSTO SC injection performance capability at apogee for the Proton M Breeze M LV. The apogee varies from 50,000 km to 65,000 km. Figure F.4.2-3 provides optimum Proton M Breeze M SSTO SC injection performance capability from the second descending node of the parking orbit (inclination of 51.5°) to an apogee of $H_a = 65,000$ km.

The current Breeze M configuration is capable of providing supersynchronous transfer missions up to 43,000 km apogee altitude. After implementation of additional modifications to the Breeze M and to the ground-based telemetry system, injection to SSTO with apogee altitudes of up to 65,000 km will become possible. The following are among the planned modifications:

- Installation of a new power supply aboard the Breeze M
- An update of onboard trajectory algorithms in the Breeze M control system
- An update of onboard Breeze M control system algorithms that are implemented during continuous rotation about the longitudinal axis
- Modification of the Breeze M control system to control new modes of telemetry data collection and transmission
- Modification of the Breeze M telemetry monitoring system to be able to use new modes of telemetry data collection and transmission
- An update of Breeze M onboard transmitters to enable use of new data transmission mode
- Equipping the ground-based telemetry system with hardware to receive telemetry and trajectory data at long ranges

Figure F.4.2-1: Typical 15-hour Breeze M Mission for SC Apogee Injection into SSTO (Ha = 65,000 km) from the Second Descending Node of a Parking Orbit Inclined at 51.5°

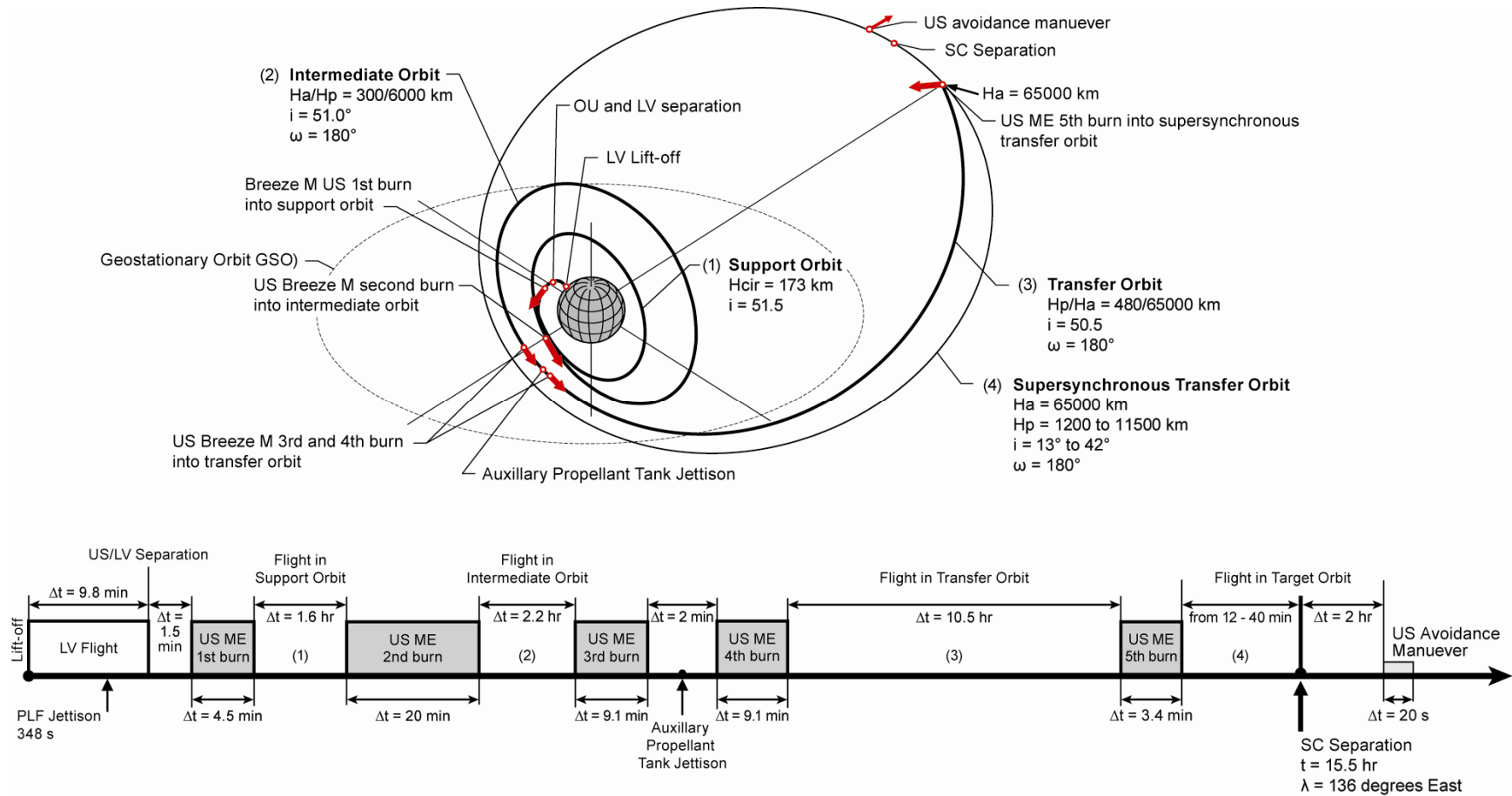
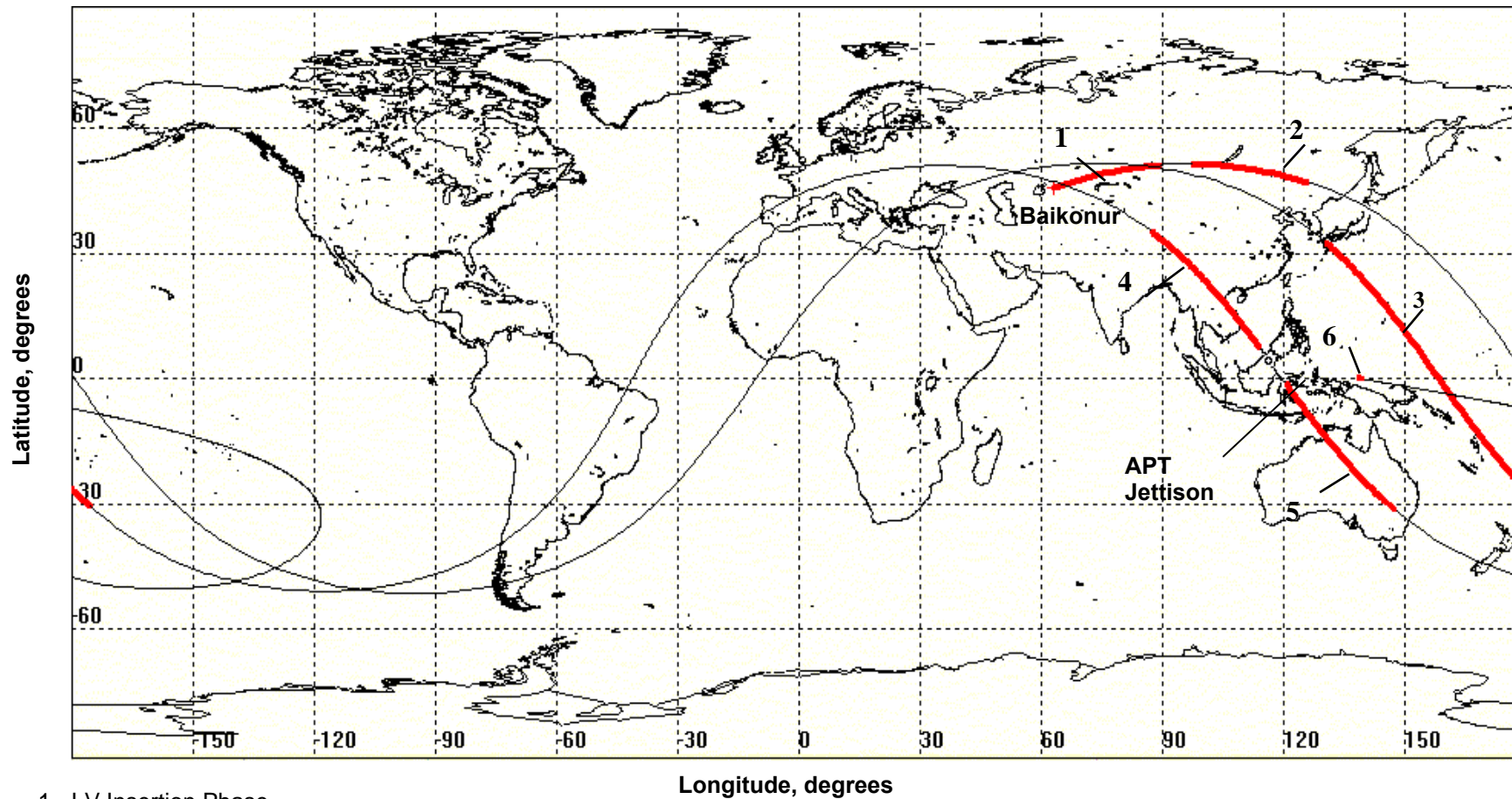

Figure F.4.2-2: Typical Proton M/Breeze M Ground Track for SC Apogee Injection into SSTO (Ha = 65000 km) Using a 15-hour Timeline from the Second Descending Node of a Parking Orbit Inclined at 51.5°



- 1 - LV Insertion Phase
- 2 - Breeze M main engine first burn and flight to support orbit
- 3 - Breeze M main engine second burn and flight to intermediate orbit
- 4, 5 - Breeze M main engine third and fourth burn and flight to supersynchronous transfer orbit
- 6 - SC Separation

Table F.4.2-1: Injection Time and Coordinates of the SC Separation Point for Apogee Injection into SSTO from the Second Descending Node of a Parking Orbit Inclined at 51.5° (Mission with Five Breeze M Burns)

SSTO Apogee (km)	SSTO Argument of Perigee (deg)	SC Injection time (hrs)	Geographic Coordinates of SC Separation Point	
			Latitude (deg)	Longitude (deg)
50000	180	12.60	0.6 N	180.2 E
55000	180	13.54	0.5 N	165.8 E
60000	180	14.50	0.4 N	151.2 E
65000	180	15.50	0.4 N	136.0 E

Table F.4.2-2: Proton M Breeze M Performance for SC Injection into Optimum SSTO from the Second Descending Node of the Parking Orbit with an Inclination of 51.5° (Profile with Five Breeze M Burns)

PSM (kg)	SSTO Parameters				Minimum SC velocity for transfer to GSO, ΔV_{sc} (m/s)
	Inclination (deg)	Perigee Altitude (km)	Apogee Altitude (km)	Argument of Perigee (deg)	
5250	13.8	11,497	65,000	180	1039
	14.3	10,961	60,000	180	1049
	14.8	10,355	55,000	180	1063
	15.2	9650	50,000	180	1081
5350	15.0	10,540	65,000	180	1084
	15.4	10,014	60,000	180	1095
	15.8	9490	55,000	180	1108
	16.2	8897	50,000	180	1126
5450	16.2	9609	65,000	180	1129
	16.5	9162	60,000	180	1139
	16.9	8742	55,000	180	1152
	17.3	8255	50,000	180	1170
5550	17.4	8772	65,000	180	1172
	17.6	8330	60,000	180	1183
	18.0	8009	55,000	180	1196
	18.35	7593	50,000	180	1214
5650	18.6	7954	65,000	180	1215
	18.8	7608	60,000	180	1226
	19.1	7322	55,000	180	1239
	19.4	6971	50,000	180	1257
5750	19.9	7210	65,000	180	1258
	20.0	6932	60,000	180	1268
	20.3	6706	55,000	180	1282
	20.5	6390	50,000	180	1300
5850	21.2	6511	65,000	180	1300
	21.3	6322	60,000	180	1310
	21.5	6128	55,000	180	1324
	21.7	5900	50,000	180	1342
5950	22.5	5855	65,000	180	1341
	22.6	5720	60,000	180	1352
	22.7	5587	55,000	180	1365
	22.85	5393	50,000	180	1384
6050	23.9	5262	65,000	180	1382
	24.0	5212	60,000	180	1393
	24.0	5108	55,000	180	1406
	24.0	4942	50,000	180	1424
6150	25.4	4760	65,000	180	1422
	25.4	4739	60,000	180	1433
	25.3	4662	55,000	180	1446
	25.2	4543	50,000	180	1463
6250	26.9	4290	65,000	180	1461
	26.8	4275	60,000	180	1473
	26.6	4225	55,000	180	1486
	26.4	4150	50,000	180	1503

PSM (kg)	SSTO Parameters				Minimum SC velocity for transfer to GSO, ΔV_{sc} (m/s)
	Inclination (deg)	Perigee Altitude (km)	Apogee Altitude (km)	Argument of Perigee (deg)	
6350	28.4	3827	65,000	180	1500
	28.2	3835	60,000	180	1512
	27.9	3812	55,000	180	1525
	27.7	3772	50,000	180	1543
6450	30.0	3408	65,000	180	1539
	29.7	3432	60,000	180	1551
	29.3	3438	55,000	180	1564
	29.0	3410	50,000	180	1583
6550	31.6	2993	65,000	180	1578
	31.2	3040	60,000	180	1590
	30.75	3060	55,000	180	1604
	30.3	3068	50,000	180	1622
6650	33.3	2625	65,000	180	1617
	32.7	2687	60,000	180	1628
	32.2	2730	55,000	180	1642
	31.65	2763	50,000	180	1661
6750	35.0	2290	65,000	180	1655
	34.3	2360	60,000	180	1666
	33.65	2430	55,000	180	1680
	33.0	2485	50,000	180	1699
6850	36.8	1993	65,000	180	1693
	35.9	2060	60,000	180	1704
	35.1	2140	55,000	180	1718
	34.4	2230	50,000	180	1737
6950	38.5	1700	65,000	180	1730
	37.6	1787	60,000	180	1742
	36.6	1890	55,000	180	1755
	35.8	1995	50,000	180	1774
7050	40.3	1440	65,000	180	1766
	39.2	1540	60,000	180	1778
	38.1	1655	55,000	180	1791
	37.2	1785	50,000	180	1810
7150	42.1	1200	65,000	180	1802
	40,9	1320	60,000	180	1814
	39,7	1452	55,000	180	1827
	38,6	1585	50,000	180	1845

Performances have been calculated for the standard PLF (15,255 mm long).
 FMHF at the PLF jettison does not exceed 1135 W/m².
 PSM includes LV AS mass.
 PSM has been defined for the Breeze M 2.33 σ propellant margin.
 During the transfer to GSO (GSO $i = 0^\circ$, $H_{cir} = 35,786$ km), the SC decreases inclination at both the apogee and perigee of the SSTO.

Note. The table does not consider perturbations resulting from solar and lunar gravitational effects.

Figure F.4.2-3: Mass of Payload System Injected Into an Optimum SSTO (Ha = 65,000 km) Using a 15-hour Apogee Injection Scheme from the Second Descending Node of the Parking Orbit with an Inclination of 51.5° (Mission Profile with Five Breeze M Main Engine Burns)

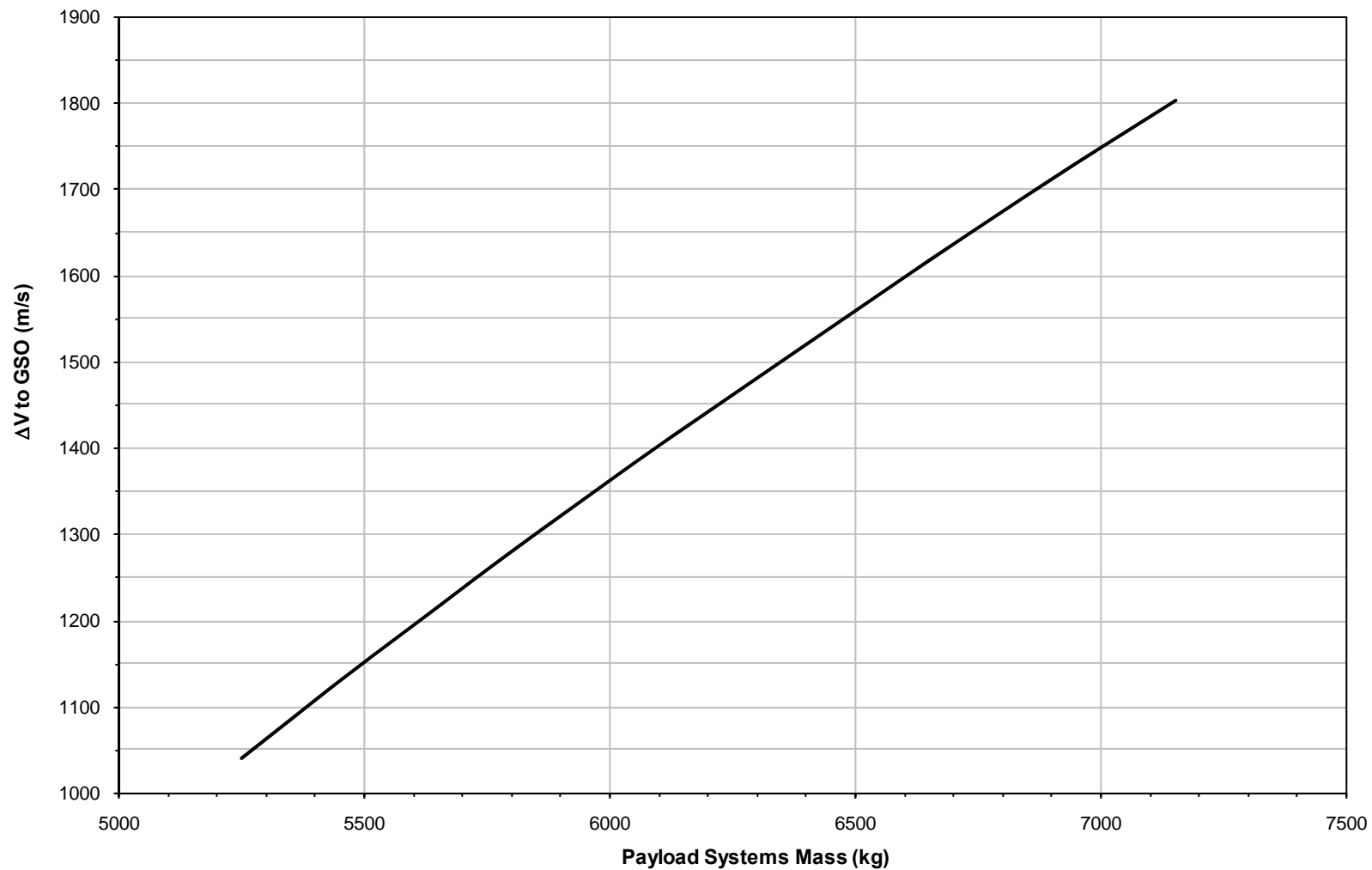

F.5 EXPRESS GTO MISSION PROFILE

For Customers desiring to reduce the mission duration below seven hours, the Proton M Breeze M is capable of reaching GTO with an "Express" mission profile.

Figure F.5-1 illustrates typical Breeze M transfer orbit characteristics for SC injection into GTO using an Express mission. The Proton M delivers the OU into a sub-orbital trajectory. Subsequent SC injection occurs using a transfer scheme with four Breeze M burns, the successive completion of which places the SC in a parking orbit (after the first burn), a transfer orbit (after the second and third burns), and the target orbit (after the fourth burn). Transfer of the OU from the parking orbit to the transfer orbit occurs at the first ascending node. The APT is jettisoned in the interval between the second and third burns. An argument of perigee of 0° is selected to assure SC separation within coverage of Russian ground measurement stations.

Table F.5-1 shows Proton M/Breeze M performance for SC express injection into GTO using a 4-hr mission timeline from the first ascending node of a parking orbit inclined at 51.5°.

Table F.5-1: Proton M/Breeze M Performance for SC Express Injection into GTO Using a 4-hour Mission Timeline from the First Ascending Node of a Parking Orbit Inclined at 51.5° (Mission with Four Breeze M Burns)

PSM (kg)	GTO Parameters				SC velocity for transfer to GSO, ΔVsc (m/s)
	Inclination (deg)	Perigee Altitude (km)	Apogee Altitude (km)	Argument of Perigee (deg)	
4070	12.6	3405	35,786	0	1300
4270	14.4	2404	35,786	0	1400
4470	16.2	1466	35,786	0	1500
Injection time – 4 hours. Performances have been calculated for the standard PLF (15,255 mm long). FMHF at the PLF jettison does not exceed 1135 W/m ² . PSM includes LV AS mass. PSM has been defined for the Breeze M 2.33σ propellant margin.					

Figure F.5-1: Breeze M Typical Injection for 4-hour Express Mission into GTO from the First Ascending Node of a Parking Orbit Inclined at 51.5°

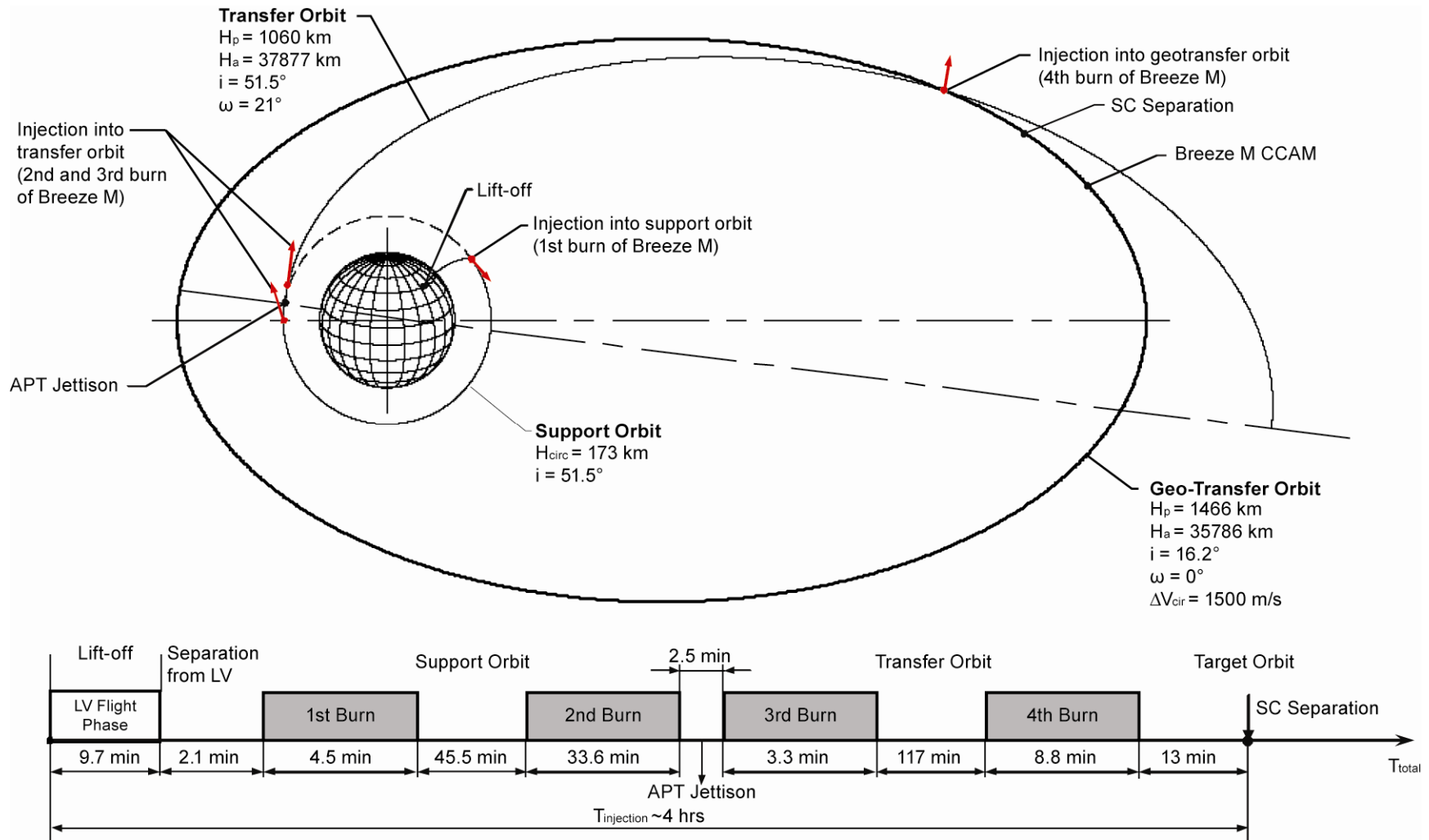

F.6 EARTH ESCAPE MISSIONS

The Proton LV has a remarkable history of launching SC into Earth escape trajectories, including multiple launches to the Moon, Mars, and Venus. Together with the Breeze M, the Proton M LV can launch a SC into an earth escape trajectory with the performance shown in Table F.6-1. Injection is accomplished using a four-burn Breeze M mission with the successive initiation of a parking orbit (after the first burn), a first intermediate orbit (after the second burn), a second intermediate orbit (after the third burn), and an escape trajectory (after the fourth burn). The APT is jettisoned after the third Breeze M burn. The time required for injection into an escape trajectory is shown in Table F.6-1. Figure F.6-1 shows the change, depending on the value of the hyperbolic excess velocity (V_{∞}), in the PSM being launched by a Proton M/Breeze M into an earth escape trajectory using a parking orbit inclined at 51.5°.

Table F.6-1: Proton M/Breeze M Performance for SC Launch into an Earth Escape Trajectory Using a Parking Orbit Inclined at 51.5° (Mission with Four Breeze M Burns)

Hyperbolic Excess Velocity, V_{∞} (m/s)	PSM (kg)	Injection Time (hrs)
0	6475	8.1
500	6445	8.1
1000	6355	8.2
1500	6205	8.4
2000	6002	8.7
2500	5748	9.0
3000	5454	9.5
3500	5124	10.2
4000	4745	11.0
4500	4361	12.2
5000	3971	13.8
5500	3556	15.0
6000	3111	15.0

Performances have been calculated for the standard PLF (15,255 mm long).
 FMHF at the PLF jettison does not exceed 1135 W/m².
 PSM includes LV AS mass.
 PSM has been defined for the US 2.33 σ propellant margin.

Figure F.6-1: Payload System Mass Injected by Proton M/Breeze M into an Earth Escape Trajectory Using a Parking Orbit Inclined at 51,5° (Mission with Four Breeze M Burns)

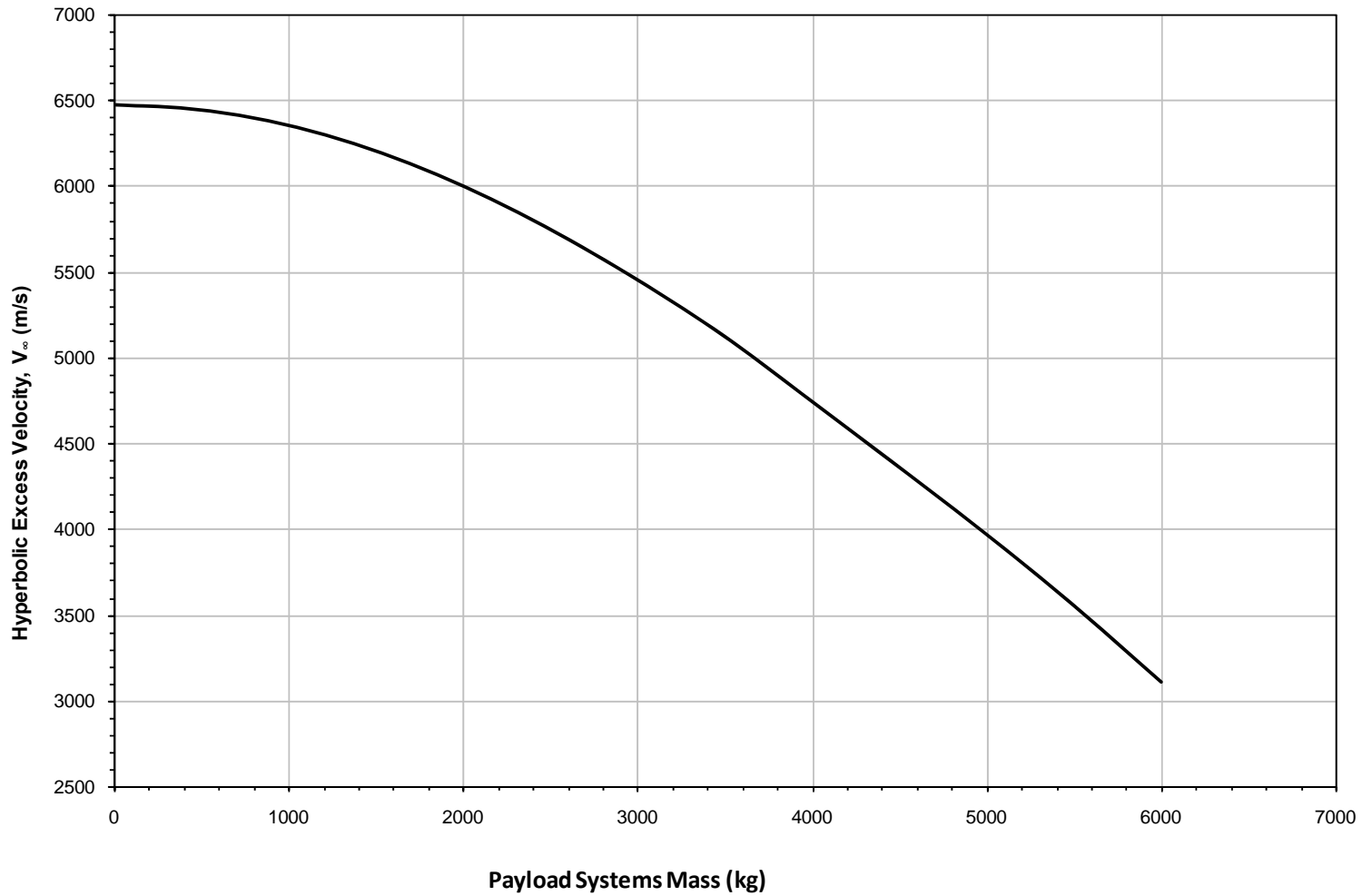

F.7 FIVE-METER DIAMETER PAYLOAD FAIRINGS

The Proton 5-meter diameter PLF, designated PLF-BR-17255, is currently under development by KhSC. This PLF has an external diameter of 5100 mm, an overall length of 17255 mm, and an internal useable volume with dimensions comparable to, or greater than, those of other 5-meter fairings available in the industry. The payload envelope under the PLF-BR-17255 fairing, using the 1666V-1000 adapter system, is shown in Figures F.7-1a and F.7-1b. As required by the Customer, other types of adapters may be used together with the PLF-BR-17255 fairing.

The Proton 5-meter PLF will be offered in conjunction with the Breeze M Upper Stage and mission design enhancements that will allow the Proton to retain a performance capability of 5850 kg to a geo-transfer orbit with a delta-V of 1500 m/s.

Other PLF options have also been assessed for development and use with the commercial Proton M Breeze M configuration. These options include PLFs with unique geometries needed to accommodate unusual SC configurations. ILS and KhSC are willing to develop these concepts with the award of firm launch services contracts. Such PLF options can take up to 48 months from contract signing to becoming available.

Figure F.7-1a: Payload Envelope Under Proton Breeze M 5-Meter PLF Fairing (Sheet 1 of 2)

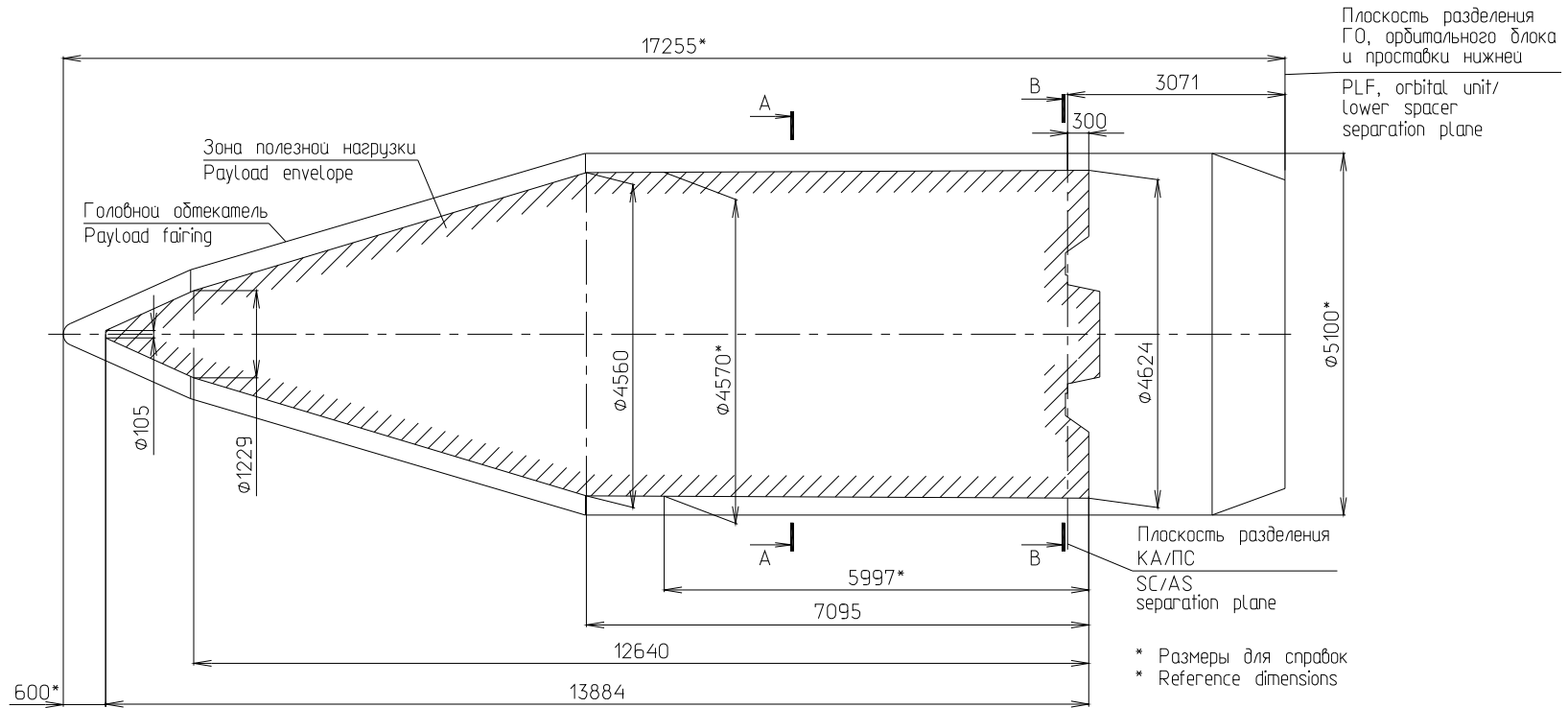
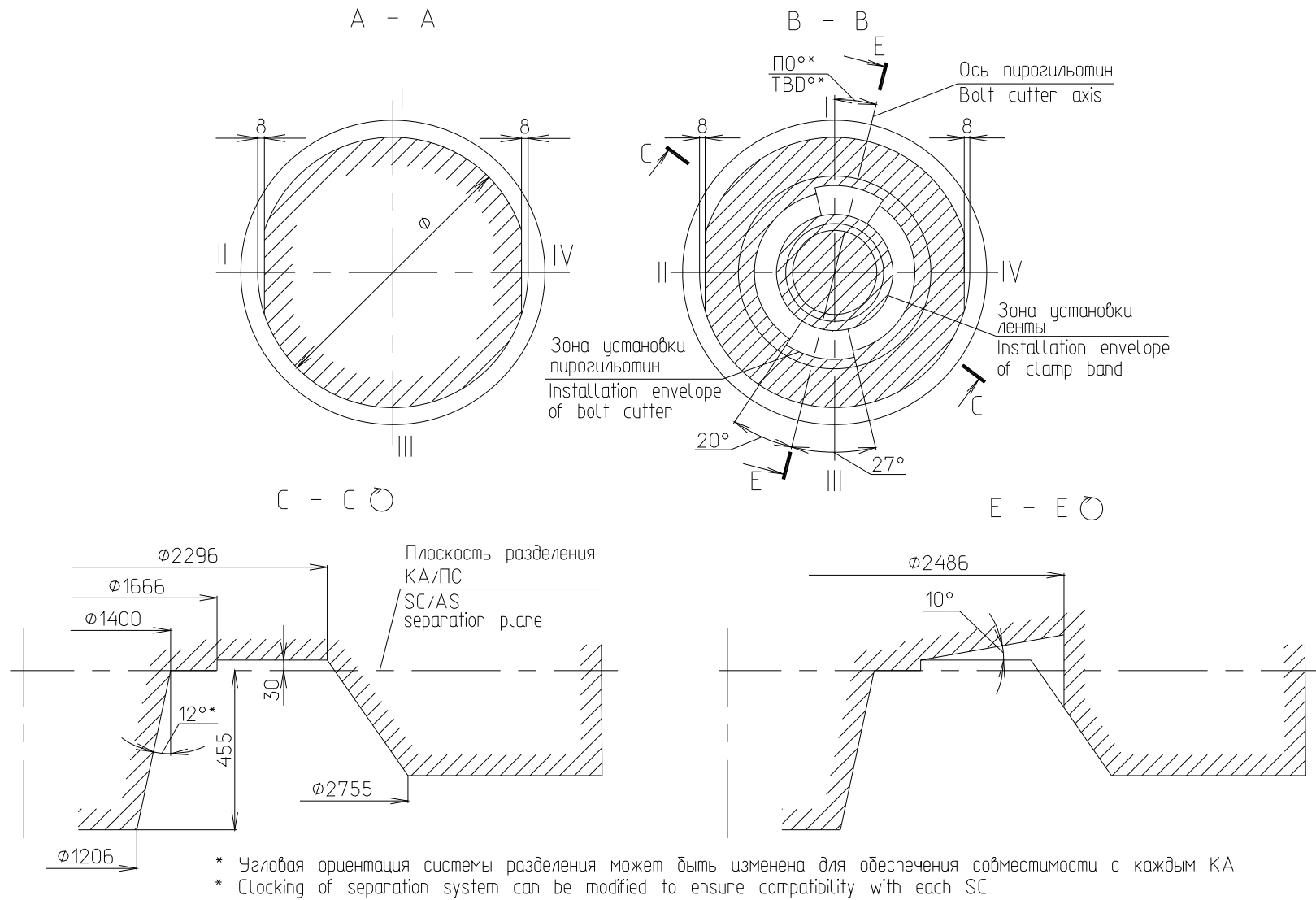

Figure F.7-1b: Payload Envelope Under Proton Breeze M 5-Meter PLF Fairing (Sheet 2 of 2)



F.8 TANDEM LAUNCH SYSTEM

In addition to large volume PLF options, KhSC has studied and conceptually designed a Tandem Launch System (TLS) payload carrier concept. The TLS concept may offer attractive opportunities for launch of multiple payload constellations to various orbits.

F.9 SHARED LAUNCH WITH THE YAKHTA SC BUS

The Russian Yakhta SC bus is designed as a load carrying structure for an adapter and second SC attached to its upper surface. The shared launch concept is offered for launches of single SC weighing less than 3200 kg. A schematic of the shared launch concept is shown in Figure F.9-1. The load carrying capability of the Yakhta SC bus in shared launch configuration is shown in Figure F.9-2. The first shared launch of Russian SC into GTO aboard a Proton M/Breeze M took place in February 2009.

Figure F.9-1: Layout of the Shared Launch Concept with the Yakhta SC Bus

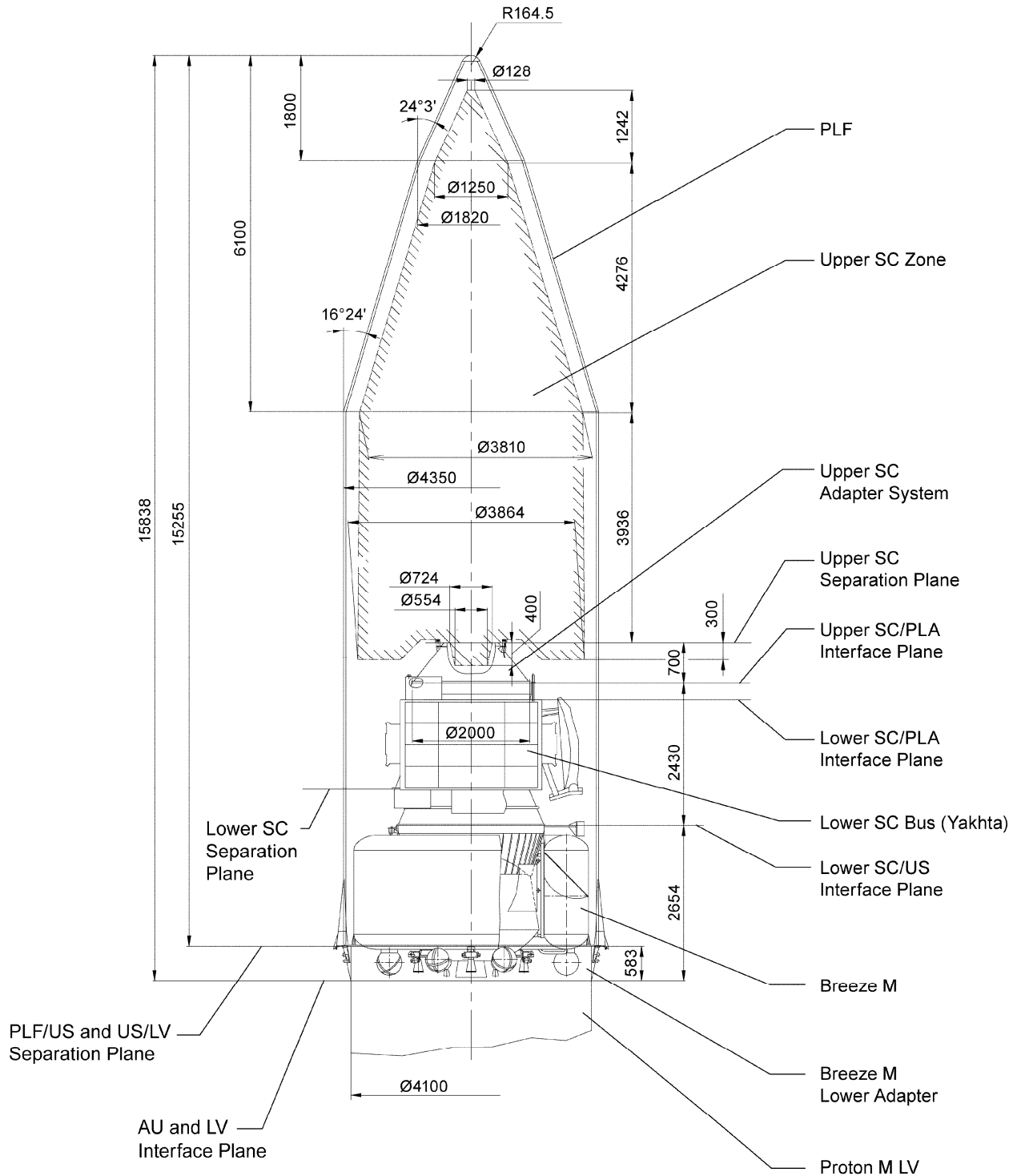
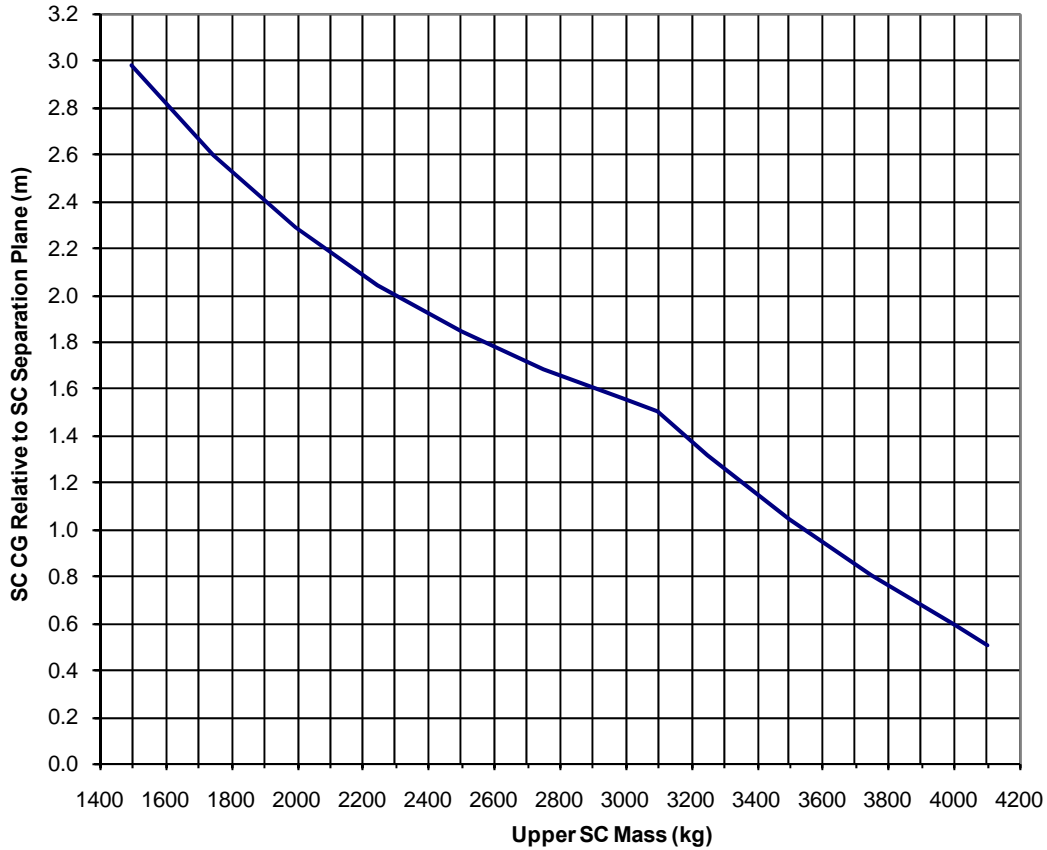

Figure F.9-2: Allowable Variation in the CG of the Second SC as a Function of the Mass of the Second SC in a Shared SC Launch on the Yakhta SC Bus



F.10 SUMMARY

As ILS and KhSC continue to explore the next evolutionary steps in Proton commercial launch services, we look forward to discussing with potential Customers their requirements for increased performance, fairing volume or mission design flexibility to meet near-term commercial launch services needs.

Intentionally Blank

Преднамеренно незаполнено